

HOUSING	OPERATING DISTANCE	MOUNTING	✓ Anti-spatter coating	✓ Robust full-metal sensor, impact resistant
M18	10 mm	Embeddable	✓ Magnetic-field immunity: medium frequency ≤ 15 kA 50 Hz fields ≤ 40 mT	✓ Long operating distance ✓ Factor 1 on Fe and Al

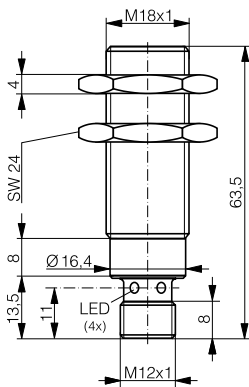

DW-AS-70x-M18-6xx

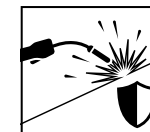
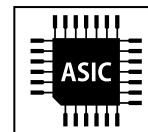
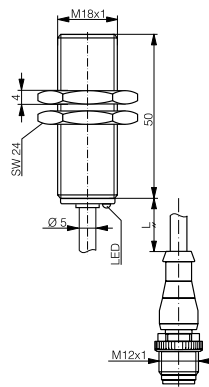

DW-AV-70x-M18-6xx

DETECTION DATA		INTERFACE	
Rated operating distance (S_n)	10 mm	Indicator LED, yellow	Sensing state ($0 \leq s \leq S_n$)
Assured operating distance (S_a)	$\leq (0.81 \times S_n)$ mm	IO-Link	✓
Repeat accuracy	≤ 0.5 mm	MTTF (@40°C)	1028 y
Hysteresis	$3\% S_r \leq \text{Hyst} \leq 15\% S_r$		
Temperature drift	$\leq 10\% S_r$		
Standard target	30 x 30 x 1 mm ³ , FE360		

Note: $0.9S_n \leq S_a \leq 1.1S_n$.

ELECTRICAL DATA		MECHANICAL DATA	
Supply voltage range (U_B)	10...30 VDC	Mounting	Embeddable
Residual ripple	$\leq 20\% U_B$	Housing material	V2A / 1.4305 / AISI 303 (+ coating)
Output current	≤ 200 mA	Sensing face material	V2A / 1.4305 / AISI 303 (+ coating)
Output voltage drop	≤ 2.0 VDC	Max tightening torque	50 Nm
Power consumption (no-load)	≤ 10 mA	Ambient operating temperature	-25...+85°C ¹
Residual current	≤ 0.1 mA	Enclosure rating	IP68 / IP69K
Switching frequency	≤ 15 Hz	Weight (cable/connector)	see page 2
Short-circuit protection	✓	Shock and vibration	IEC 60947-5-2
Voltage reversal protection	✓		
Cable length max.	≤ 300 m		

¹Maximum temperature according to UL: 70°C.

Note: all data measured according to IEC 60947-5-2 standard with $U_B=20 \dots 30$ VDC, $T_A=23^\circ\text{C} \pm 5^\circ\text{C}$.

CORRECTION FACTORS FOR TARGET OF

Steel FE 360	1	Copper	0.85	Aluminum	1	Brass	1.3	Stainless Steel V2A 1/2 mm	0.4 / 0.8
--------------	---	--------	------	----------	---	-------	-----	----------------------------	-----------

CORRECTION FACTORS FOR EMBEDDABLE MOUNTING IN SUPPORT OF

Steel FE 360	0.7	Aluminum	0.7	Brass	0.55	Stainless Steel V2A	0.65
--------------	-----	----------	-----	-------	------	---------------------	------

Note: the operating distance of the sensor must be multiplied by the correction factor of the material. For example, the operating distance on Aluminum is $S_{n,Al} = S_n \times CF_{Al}$. In case of embeddable mounting, the distance is multiplied by the additional correction factor of the support, thus $S_{n,Al} = S_n \times CF_{Al} \times CF_{emb,Al}$.

INSTALLATION CONDITIONS

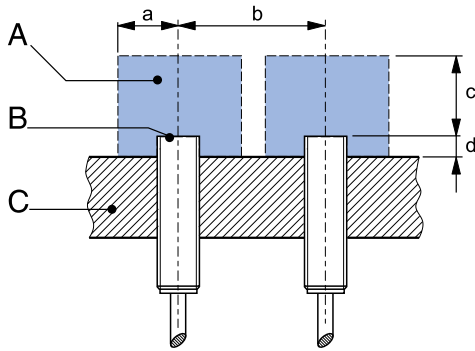

A : metal free zone a : 25 mm d : steel 0 mm
 B : sensing face b : 50 mm
 C : support c : 30 mm

Note: additional installation information can be found in the glossary of the Contrinex General Catalog.

IO-LINK FUNCTIONALITIES

IO-Link version	1.1
SIO mode	Supported
Process data	7-bit input
Baudrate	COM2 (38.4 kBaud)
Minimum cycle time	10.4 ms
ISDU	Not supported



IO-Link files may be downloaded from

www.contrinex.com/product-range/inductive-sensors/.

Select the product name to display the product page with corresponding downloads.

Alternatively, just click/scan the QR code on the left.

WIRING DIAGRAM

PIN ASSIGNMENT

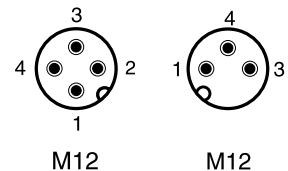
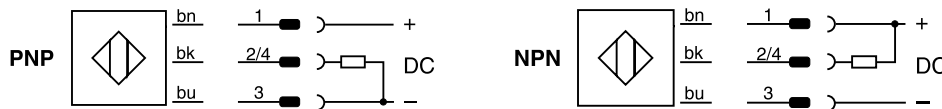

AVAILABLE TYPES

UNCOATED

Part number	Part reference	Old ref.	Polarity	Connection	Output on pin 2	Output on pin 4 / bk	Weight
330-320-145	DW-AS-703-M18-673	-	PNP	M12 4-pin	-	Normally open (NO)	53 g
320-420-763	DW-AV-701-M18-673	xxx-692	NPN	PUR, 0.2m + M12 3-pin	-	Normally open (NO)	66 g
330-320-169	DW-AV-703-M18-673	xxx-695	PNP	PUR, 0.2m + M12 3-pin	-	Normally open (NO) / IO-Link	66 g
320-420-765	DW-AS-701-M18-673	-	NPN	M12 4-pin	-	Normally open (NO)	53 g

COATED

Part number	Part reference	Old ref.	Polarity	Connection	Output on pin 2	Output on pin 4 / bk	Weight
330-320-162	DW-AS-703-M18-697	-	PNP	M12 4-pin	-	Normally open (NO)	53 g
320-420-780	DW-AV-701-M18-693	xxx-696	NPN	PUR, 0.2m + M12 3-pin	-	Normally open (NO)	66 g
330-320-170	DW-AV-703-M18-693	xxx-696	PNP	PUR, 0.2m + M12 3-pin	-	Normally open (NO) / IO-Link	66 g

Note: part reference may include additional suffix to indicate a revision version or special version. Further information is available on request.

Operators of the products we supply are responsible for compliance with measures for the protection of persons. The use of our equipment in applications where the safety of persons might be at risk is only authorized if the operator observes and implements separate, appropriate and necessary measures for the protection of persons and machines. Terms of delivery and rights to change design reserved.