

5'000 mm

- ✓ Time-of-flight (TOF)
- ✓ Laser emission
- ✓ High precision
- ✓ Settable outputs
- ✓ Reliable measurement of tilted objects

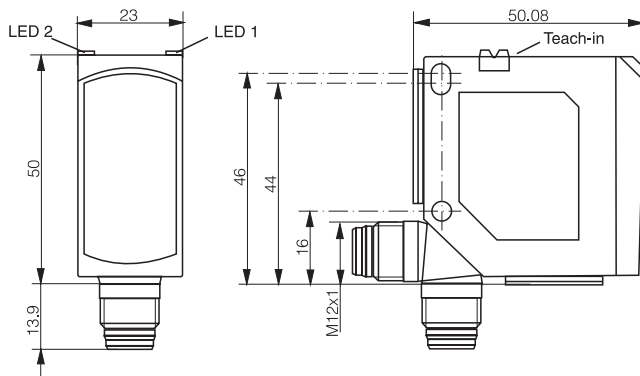
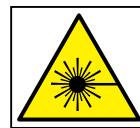

OPTICAL DATA		INTERFACE	
Measurement range	100...5'000 mm ¹	Adjustment	Teach button or teach input
Resolution	< 5 mm	Indicator LED, green	Supply voltage state
Linearity	± 30 mm ¹	Indicator LED, yellow	Sensing state
Repeatability	see diagram	IO-Link	No
Light source	Laser class 1, red 650 nm		
Light spot size (distance)	5 x 4 mm ² (3'000 mm)		

¹Object with 18%...90% reflectance (standard gray to white paper)

ELECTRICAL DATA		MECHANICAL DATA	
Supply voltage range (U _b)	18...30 VDC	Enclosure rating	IP67 & IP69K
Analog output (current version)	4...20 mA, max. load 500 Ohms	Ambient temperature operation	-40...+60°C (UL: max +45°C)
Analog output (voltage version)	0...10 V, min. load 4k Ohms	Shock and vibration	IEC 60947-5-2
Output current	≤ 100 mA	Weight (connector version)	42 g
Signal PNP high/low	≤ (U _b -2.0 V)/ approx. 0 V	Weight (cable version)	-
Signal NPN high/low	Approx. U _b / ≤ 2.0 V	Housing material	ABS
Power consumption (no load)	≤ 60 mA	Window material	PMMA
Response time (analog)	2 ms	Connection cable	-
Switching frequency	≤ 250 Hz	Connector type	M12 5-pin
Short circuit protection	✓		
Voltage reversal protection	✓		

MEASUREMENT RANGE

CHARACTERISTIC CURVE (INVERTIBLE & ADJUSTABLE)

Target	Measurement range
90%	100...5'000 mm
18%	100...5'000 mm
6%	100...3'000 mm

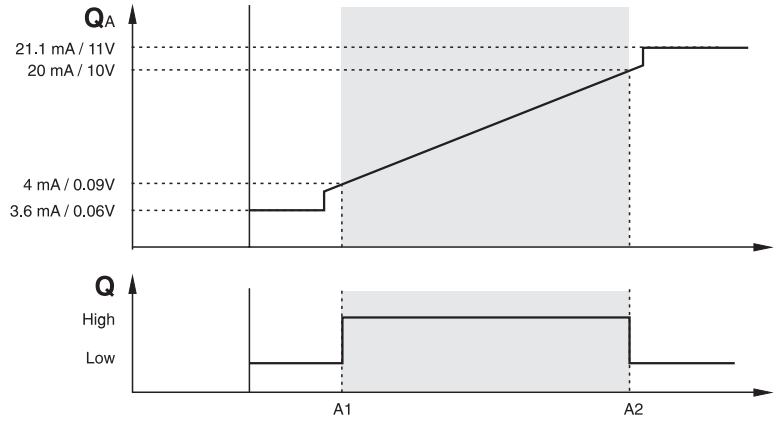

REPEATABILITY¹

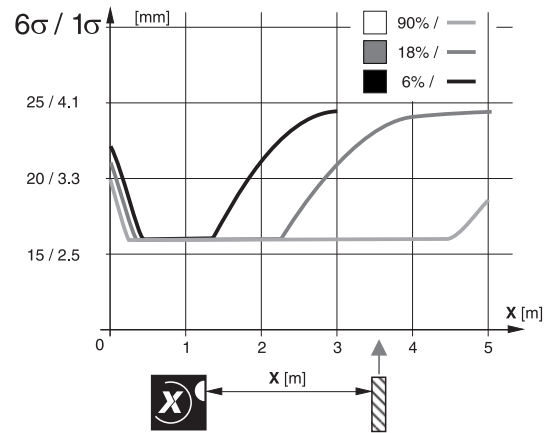
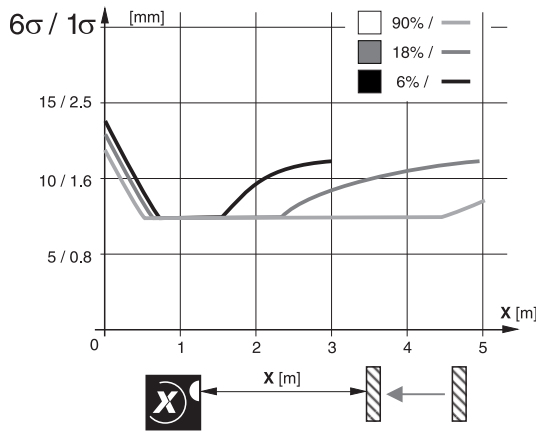

¹At constant ambient conditions

WIRING DIAGRAM

PIN ASSIGNMENT

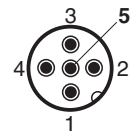
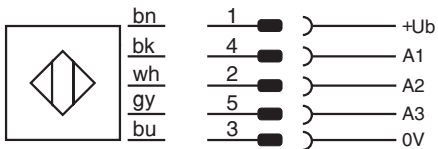

M12

AVAILABLE TYPES

Part number	Part reference	Polarity	Connection	Output (A1)	Output (A2)	Input (A3)
628 000 698	DTL-C55PA-TMS-119-502	PNP/NPN auto-detect	Connector M12 5-pin	Light/Dark-on	4...20 mA	Teach
628 000 699	DTL-C55PA-TMS-119-503	PNP/NPN auto-detect	Connector M12 5-pin	Light/Dark-on	0...10 V	Teach

Note: additional suffix can appear to indicate a revision version or a special version.

Operators of the products we supply are responsible for compliance with measures for the protection of persons. The use of our equipment in applications where the safety of persons might be at risk is only authorized if the operator observes and implements separate, appropriate and necessary measures for the protection of persons and machines. Terms of delivery and rights to change design reserved.

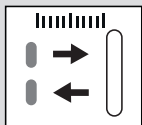

5'000 mm

- ✓ Time-of-flight (TOF)
- ✓ Émission laser
- ✓ Haute précision

- ✓ Sorties réglables
- ✓ Détection fiable d'objets inclinés

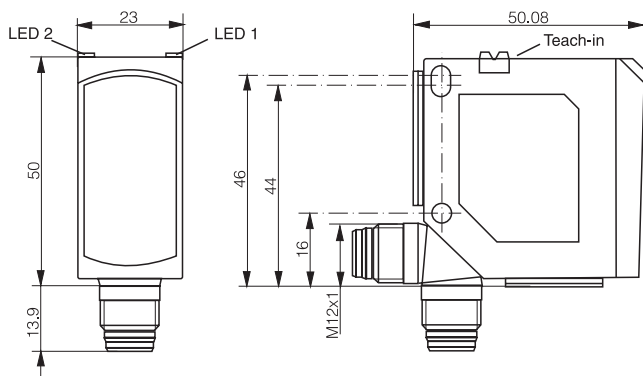
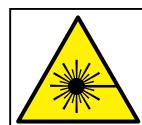

DONNÉES OPTIQUES

Domaine de mesure	100...5'000 mm ¹
Résolution	< 5 mm
Linéarité	± 30 mm ¹
Répétabilité	voir schéma
Source lumineuse	Laser classe 1, rouge 650 nm
Taille tache lumineuse (distance)	5 x 4 mm ² (3'000 mm)

¹Objet avec 18%...90% de réflectance (papier gris...blanc standard)

INTERFACE

Réglage	Bouton 'teach' ou entrée 'teach'
Indicateur LED, vert	État de la tension d'alimentation
Indicateur LED, jaune	État de détection
IO-Link	Non

DONNÉES ÉLECTRIQUES

Tension d'alimentation (U _b)	18...30 VDC
Sortie analogique (version courant)	4...20 mA, charge max. 500 Ohms
Sortie analogique (version tension)	0...10 V, charge min. 4k Ohms
Courant de sortie	≤ 100 mA
Signal PNP high/low	≤ (U _b -2.0 V)/ env. 0 V
Signal NPN high/low	env. U _b / ≤ 2.0 V
Consommation (hors charge)	≤ 60 mA
Temps de réponse (analogique)	2 ms
Fréquence de commutation	≤ 250 Hz
Protection contre les courts circuits	✓
Protection contre les inversions	✓

DONNÉES MÉCANIQUES

Indice de protection	IP67 & IP69K
Temp. ambiante d'utilisation	-40...+60°C (UL: max +45°C)
Chocs et vibrations	IEC 60947-5-2
Poids (version connecteur)	42 g
Poids (version câble)	-
Matériau du boîtier	ABS
Matériau de la fenêtre	PMMA
Câble de raccordement	-
Type de connecteur	M12 5 pins

DOMAINE DE MESURE | **CARACTÉRISTIQUE DE LA COURBE (INVERSIBLE & RÉGLABLE)**

Cible	Domaine de mesure
90%	100...5'000 mm
18%	100...5'000 mm
6%	100...3'000 mm

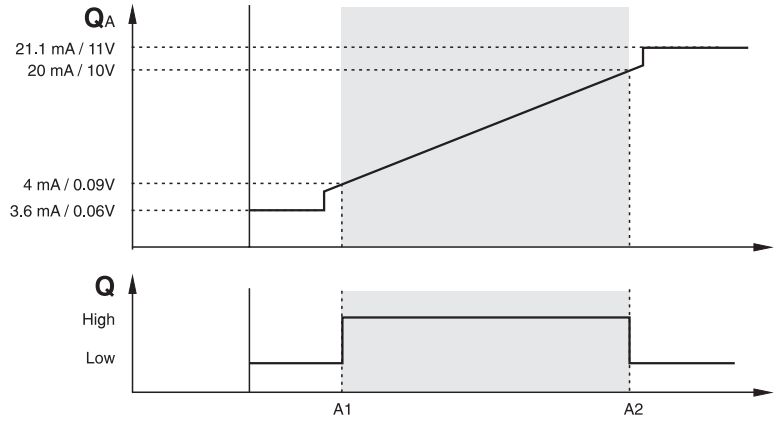

RÉPÉTABILITÉ¹

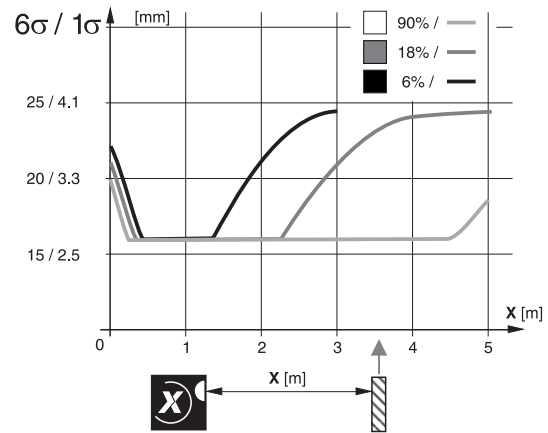
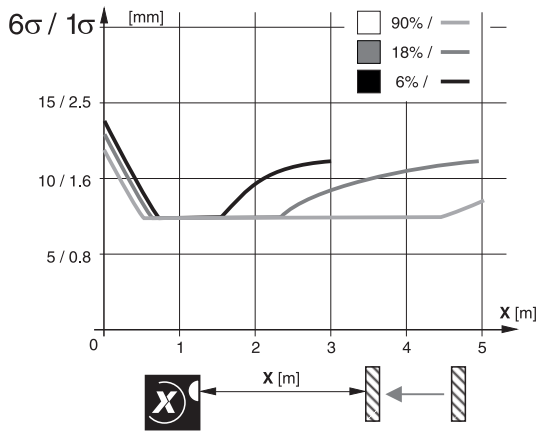

¹Dans des conditions ambiantes constantes

SCHÉMA DE RACCORDEMENT | **ATTRIBUTION DES PINS**

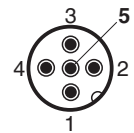
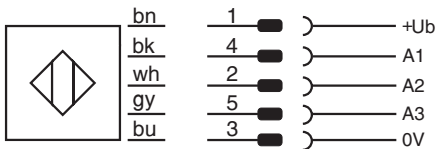

M12

TYPES DISPONIBLES

No. d'article	Désignation	Polarité	Raccordement	Sortie (A1)	Sortie (A2)	Entrée (A3)
628 000 698	DTL-C55PA-TMS-119-502	PNP/NPN détect. auto	Connect. M12 5 pins	en/sans récept.	4...20 mA	Teach
628 000 699	DTL-C55PA-TMS-119-503	PNP/NPN détect. auto	Connect. M12 5 pins	en/sans récept.	0...10 V	Teach

Remarque: la présence d'un suffixe supplémentaire indique une version révisée ou une version spéciale.

Les exploitants des produits que nous fournissons sont tenus d'assurer des mesures adéquates de protection des personnes. L'utilisation de nos appareils dans des applications comportant un risque possible pour la sécurité des personnes n'est admissible que si l'exploitant observe et met en œuvre des mesures séparées, appropriées et nécessaires pour la protection des personnes et des machines. Sous réserve de modifications et de possibilités de livraison.

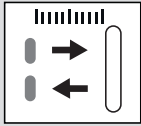

5'000 mm

- ✓ Time-of-flight (TOF)
- ✓ Laseremission
- ✓ Hohe Präzision
- ✓ Ausgänge einstellbar
- ✓ Zuverlässiges Erkennen gekippter Objekten

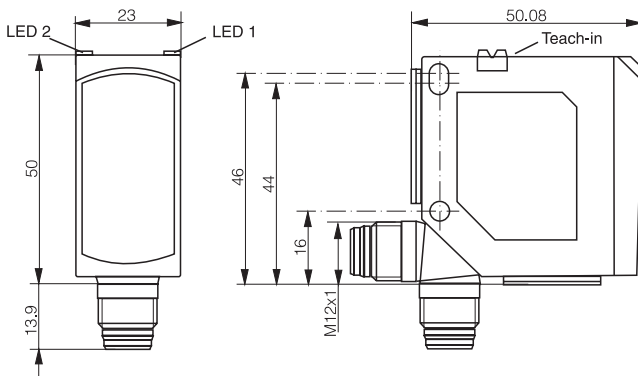
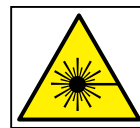

OPTISCHE DATEN		INTERFACE	
Messbereich	100...5'000 mm ¹	Einstellung	Teach-Taste oder -Eingang
Auflösung	< 5 mm	Anzeige-LED, grün	Versorgungsspannungs-Status
Linearität	± 30 mm ¹	Anzeige-LED, gelb	Erfassungsstatus
Wiederholgenauigkeit	siehe Schema	IO-Link	Nein
Lichtquelle	Laserklasse 1, rot 650 nm		
Lichtfleckgrösse (Entfernung)	5 x 4 mm ² (3'000 mm)		

¹Objekt mit 18...90% Reflexion (standardgraues...-weisses Papier)

ELECTRISCHE DATEN		MECHANISCHE DATEN	
Versorgungsspannungsber. (Ub)	18...30 VDC	Schutzart	IP67 & IP69K
Analogausgang (Stromversion)	4...20 mA, max. Last 500 Ohms	Umgebungstemperatur Betrieb	-40...+60°C (UL: max +45°C)
Analogausg. (Spannungsversion)	0...10 V, min. Last 4k Ohms	Schocks und Vibrationen	IEC 60947-5-2
Ausgangsstrom	≤ 100 mA	Gewicht (Steckerversion)	42 g
PNP-Signal high/low	≤ (Ub-2.0 V)/ ca. 0 V	Gewicht (Kabelversion)	-
NPN-Signal high/low	ca. Ub/ ≤ 2.0 V	Gehäusematerial	ABS
Stromaufnahme (ohne Last)	≤ 60 mA	Fenstermaterial	PMMA
Ansprechzeit (analog)	2 ms	Anschlusskabel	-
Schaltfrequenz	≤ 250 Hz	Anschlusstecker	M12 5-Pin
Kurzschlusschutz	✓		
Verpolungsschutz	✓		

MESSBEREICH

KENNLINIE (INVERTIERBAR UND EINSTELLBAR)

Objekt	Messbereich
90%	100...5'000 mm
18%	100...5'000 mm
6%	100...3'000 mm

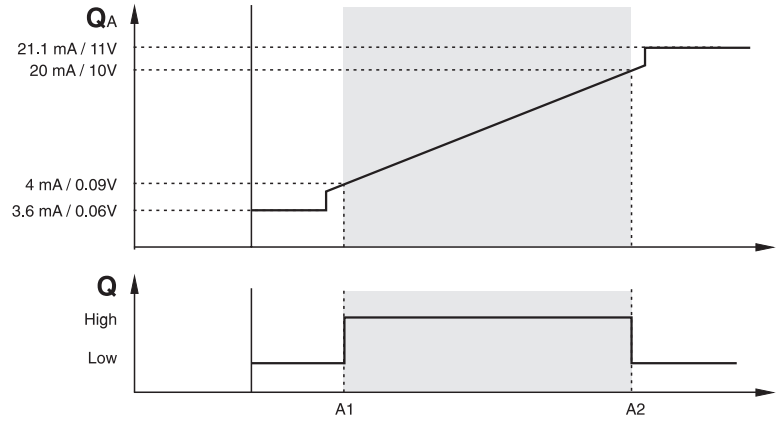

WIEDERHOLGENAUIGKEIT¹

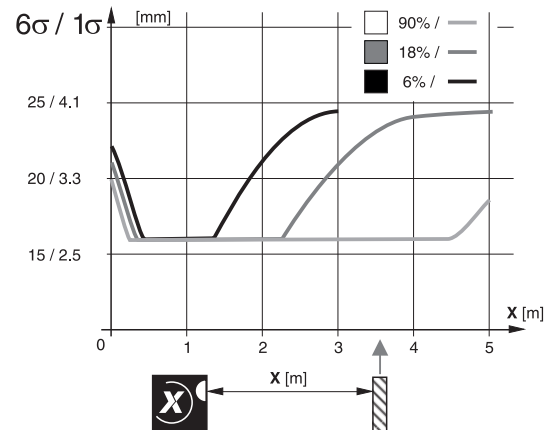
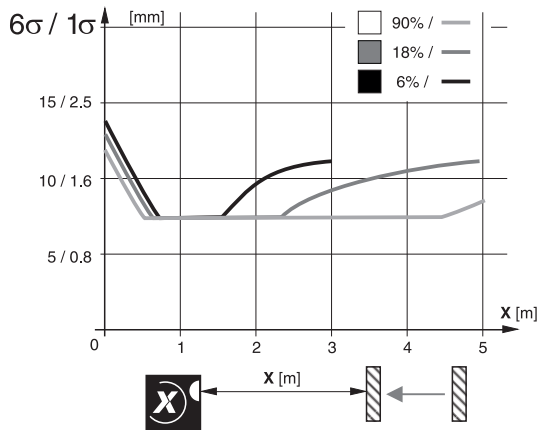

¹Bei konstanten Umgebungsbedingungen

ANSCHLUSSSCHEMA

STECKERBELEGUNG

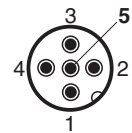
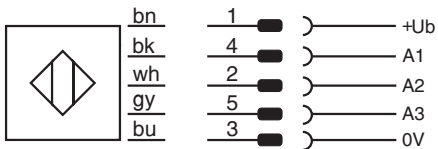

M12

VERFÜGBARE TYPEN

Art.-Nummer	Bezeichnung	Polarität	Anschluss	Ausgang (A1)	Ausgang (A2)	Eingang (A3)
628 000 698	DTL-C55PA-TMS-119-502	PNP/NPN Auto-Detect	Stecker M12 5-Pin	hell-/dunkelsch.	4...20 mA	Teach
628 000 699	DTL-C55PA-TMS-119-503	PNP/NPN Auto-Detect	Stecker M12 5-Pin	hell-/dunkelsch.	0...10 V	Teach

Hinweis: Im Fall einer überarbeiteten Version oder Sonderausführung kann die Bezeichnung auch durch eine Endung ergänzt werden.

Die Einhaltung der Personenschutzmaßnahmen obliegt dem Betreiber der von uns gelieferten Produkte. Der Einsatz unserer Geräte in Anwendungen, bei welchen die Sicherheit von Personen gefährdet sein könnte, ist nur dann zulässig, wenn der Betreiber gesonderte geeignete und notwendige Maßnahmen für die Personen- und Maschinensicherheit einhält und vornimmt. Änderungen und Liefermöglichkeiten vorbehalten.