

P33 Safety Exhaust Valve Externally Monitored

Bulletin 0700-B14



ENGINEERING YOUR SUCCESS.

Safety Exhaust Valve

Features – Externally Monitored

Safety Exhaust Valve Function

When applications demand a safe environment you can count on safety valves from Parker Hannifin. The P33 family of safety exhaust valves are 3/2 normally closed valves designed to rapidly exhaust compressed air in the event of a fault condition and to provide monitored coverage ensuring safe function. The P33 is available in two distinct styles, internally* or externally monitored. The valve is suitable for use up to Category 4, performance level e. Monitoring is achieved externally via a two channel system connected to a safety interface device. Both valves are available with an adjustable soft start and high flow exhaust to shut your equipment down faster when needed. LED's provide clear status of main solenoid operation, sensor power and fault condition for quick visual reference.

Externally Monitored Valve, Faults and Resets

The externally monitored valve has the monitoring done via a PLC or relay which offers a size and cost advantage over internally monitored valves. The integration of a safety interface into the PLC or relay will help determine the achievable category and performance level of the control system. Customers are required to provide the logic function via the safety device. The valve will lock-out to the "safe state" if asynchronous movement of the valve elements occur which will be detected by solid state pressure sensors. To achieve the proper safety rating, the safety PLC or relay must monitor the solid state pressure sensors to ensure they are not in different states for more than 150ms. If the sensors are in different states for longer than 150ms then the programming logic must shut off power to the solenoids and consider it a fault condition. If during operation the externally monitored P33 enters a fault condition the valve will shut off. A separate reset signal must be incorporated into the logic sequence to avoid automatic restart of the valve. The safety exhaust valves are not for use with clutch or brake applications and are designed for use in conjunction with a safety relay or safety PLC for safe monitoring and fault detection.

Achieving Desired Performance Level **

The category and performance level (PLr) needed for your machine is determined by a risk assessment of the machinery design and application based on EN ISO 13849-1. The Parker P33 safety valve is designed for those applications requiring a PL of d or e. Please note these levels require other aspects of the system to meet these requirements. As a guide: you can achieve a Cat 4 PL e system by integrating monitoring via a programmable safety rated device. Because the P33 is a mechanical fail-safe device, the monitoring could also be done via a standard PLC and still attain as high as a PL d rating.

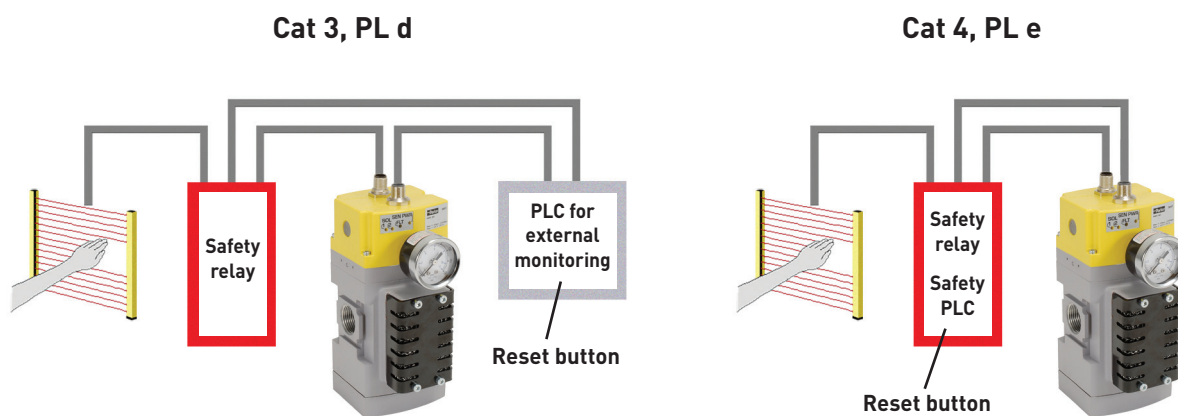

* For information on internally monitored safety valves reference Bulletin 0700-B13.

** An integration guide is available to provide further information on connecting the safety valve product to achieve the desired performance level. Please consult Parker and the standard EN ISO 13849-1 for more information.

Safety Exhaust Valve

Features – Externally Monitored



(optional soft start)



- Easy electrical interface with M12 connectors to safety circuit
- External monitoring provides a cost and space saving advantage
- Solid state pressure sensors provide accurate, fast fault detection
- Quick visual LED indicators on the front of the valve
- Superior seated seal design for longer life
- Safety exhaust outlet is no-maintenance and non-clog by design
- Suitable for stand alone use or modular mounting to P32 or P33 FRL assembly
- High B10 life value

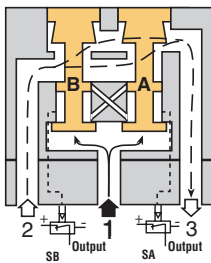

Conditions at Start

The Safety exhaust valve starts with inlet 1 closed to outlet 2 by both valve elements A and B. Outlet 2 is open to exhaust 3. Pressure signals at both sensors SA and SB are exhausted and contacts 1 and 2 of sensors SA and SB are connected. The normally closed sensors both provide voltage feedback signals to the external monitoring system.

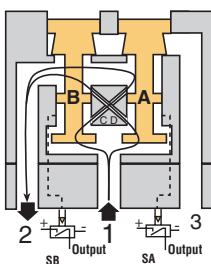

Normal Operation

During normal operation the two solenoids are simultaneously energized which actuates both pilots and causes valve elements A and B to shift. Inlet 1 is then connected to outlet 2 via crossflow passages C and D. Exhaust 3 is closed. Sensing pressure signals go to each pressure sensor and become equal to inlet pressure. Both sensors contacts open and no voltage signals are provided to the external monitoring system. This indicates that both sides of the valve actuated as expected.

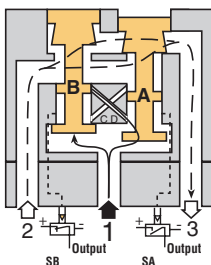

Detecting a Malfunction

A malfunction in the system or the valve itself could cause one valve element to be open and the other closed. Air then flows past the inlet poppet on valve element A, into crossflow passage D, but is substantially blocked by the spool portion of element B. The large size of the open exhaust passage past element B keeps the pressure at the outlet port below 2% of inlet pressure. Full sensing air pressure from side A goes to sensor SA, and a reduced pressure goes to sensor SB. This full pressure signal causes SA to open. Sensor SB, with a reduced pressure signal, does not open. An external monitoring system can detect the malfunction by monitoring the outputs of the SA and SB sensors. The external monitor system must then react accordingly by shutting down the power to the valve solenoids and any other components deemed necessary to stop the machine.

Safety Exhaust Valve

Technical Data

Externally Monitored (with Soft Start)

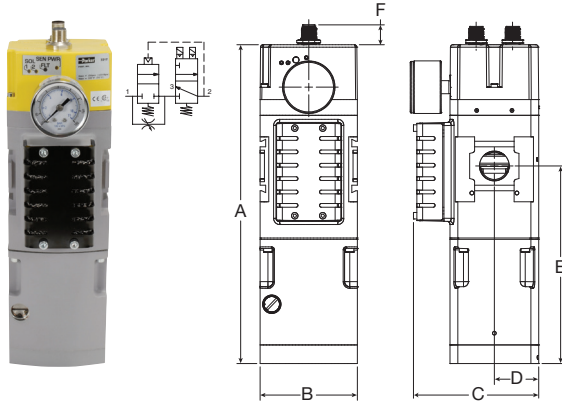

Externally Monitored (No Soft Start)

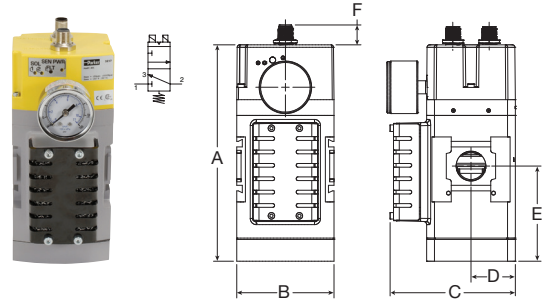

Dimensions

	Ports	Standard nominal flow rate		A	B	C	D	E	F
		1 → 2 L/min (SCFM)*	2 → 3 L/min (SCFM)*						
Externally Monitored with soft start	3/4"	4,100 (145)	7,500 (265)	10.31 (261.9)	3.15 (80)	4.30 (109.3)	1.44 (36.5)	6.39 (162.3)	0.64 (16.3)
Externally Monitored no soft start	3/4"	4,300 (152)	7,500 (265)	7.03 (178.7)	3.15 (80)	4.30 (109.3)	1.44 (36.5)	3.11 (79.0)	0.64 (16.3)

* Standard nominal flow rate is based on 6 bar input pressure with $\Delta P = 1$ bar

General Technical Data

Valve type	Externally monitored, redundant, dual poppet
Soft start	Optional
Valve function	3/2 way, normally closed
Housing material	Cast aluminum
Seals	NBR
Fasteners	Stainless steel / brass
Silencer	Steel, non clog safety design
Weight lbs (kg)	6.5 (2.9) with soft start 4.2 (1.9) without soft start

Electrical Specifications

Operating voltage	24V DC
Electrical connection	Two M12 connectors
Switching time 1-2 (ms)	23.3
Switching time 2-3 (ms)	42.7
Duty cycle (%)	100%
Operating voltage (DC)	21.6 to 26.4
Nominal power	
per solenoid coil at 24V DC (W) +/- 10%	1.2 W
per pressure sensor at 24V DC	1.2 W

In accordance with EN ISO 13849-1 this safety valve is suitable for use up to Category 4, Ple, sil 3. Certified to cCSAus and bears the CE mark.

Supply Voltage: For CSA/UL compliance, in DC applications the valve must be connected to a NEC Class 2 power supply.

A product Integration Guide is available to help connect your logic controller to the Parker Safety Exhaust Valve under the Product Support tab at www.parker.com/pdn/safetyvalve

Specifications

Operating pressure PSIG (bar)	30 to 150 PSIG (2 to 10 bar)	B10 _d (mio)	25 million switching cycles
Minimum operating pressure PSIG (bar)	30 PSIG (2 bar)	MTTFD	B10D / (0.1xNop), (Nop=number of annual operation cycles)
Ambient temperature °F (°C)	40° to 120°F (4° to 50°C)	SIL	3
Recommended filtration (µ)	40µ	Allowable discordance	150ms
Operating medium	Compressed air	Flow media	Compresses air to ISO 8573-1 Class 7:4:4
Ingress protection class	IP65		
B10 (mio)	12.5 million switching cycles		

The soft start opens to full flow at approximately 60% of input pressure.

Machinery Directive Overview

The Machinery Directives' goal is to protect people and the environment from accidents caused from all types of machinery. Based on the standard EN 13849 [safety of machines; safety-related parts of control systems] these standards build the procedure to assess safety-related control systems.

Required Performance Level (PLr) based on a risk assessment are now commonly used to determine the safety level required for the controls system, for the application of machinery.

Performance Level (PL) based on the original B, 1,2,3,4 safety categories, diagnostic capabilities, Mean time to dangerous failure (MTTF_D), and common cause failure (CCF), define safety levels of a given safety function. This ensures that safety is not just focused on component reliability, but instead introduces common sense safety principles such as redundancy, diversity, and fail-safe behavior of safety related control parts.

The new EN 13849 standards of the Machinery Directive dictates the machine is safe when the Performance Level of the safety control circuit is equal to or greater than the Required Performance Level of the application. When determining the required performance level, the greater the risk, the higher the requirements of the control system.

$$PLr \leq PL$$

Determining PLr According to EN 13849-1

The level of each hazardous situation is classified in five Performance levels from a to e. With PL a the control functions contribution to risk reduction is low, while at PL e it is high. The risk graph above can be used as a guideline to determine the required performance level PLr for safety function.

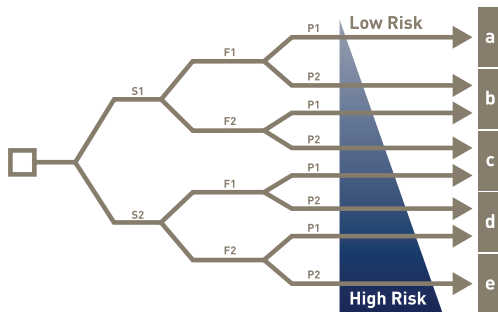

Risk Parameters

(S) Severity of injury

- S1 Slight (normally reversible injury)
- S2 Serious (normally irreversible injury, or death)

(F) Frequency and / or duration of exposure to hazard

- F1 Seldom to less often and / or brief
- F2 Frequent to continuous and / or long

(P) Possibility of avoiding the hazard

- P1 Possibility of avoiding the hazard
- P2 Scarcely ever possible

Determining PL According to EN 13849-1

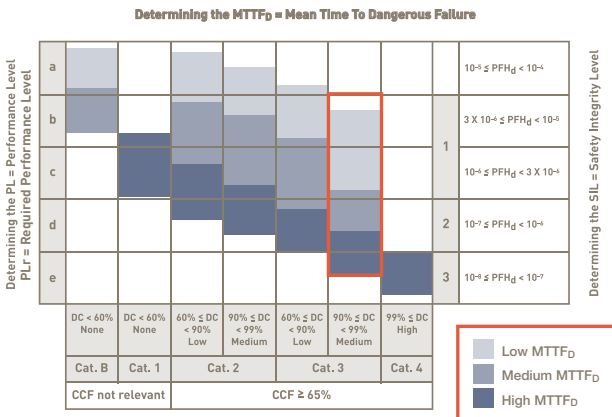

Categories Defined by EN 13849-1

Category	Summary
Category B	When a fault occurs it can lead to the loss of the safety function.
Category 1	Same that Category B, but loss of the safety function is less likely thanks to a good MTTF _D of each channel.
Category 2	System behavior allow that the occurrence of a fault can lead to the loss of the safety function between the checks; the loss of the safety function is detected by the check.
Category 3	A single fault in any of safety related parts does not lead to the loss of the safety function. Whenever reasonably possible the single fault shall be detected at or before the next demand upon the safety function. (Means redundancy)
Category 4	Same as Category 3, but if detection of single fault is not possible on or before the next demand upon the safety, an accumulation of these undetected faults shall not lead to the loss of the safety function. (Means redundancy & check)

Safety Exhaust Valve

Ordering Information

Ordering Information

P3	3	T	B	1	6	A	B	E	N
Series Standard P3	Global Standard 3	Type Safety redundant (no soft start) D Safety redundant (c/w soft start) T	Design Current B	Thread type BSPP 1 NPT 9	Port size 3/4" 1 6	Output for Solenoid, M12 Connector Pin 2 & 4, common 3 A 3 & 4 C 2 & 4 D	Output for Sensors, M12 Connector Pin 1 & 2, 1 & 4, common 3 A 1 & 2, 5 & 4, common 3 B 5 & 2, 1 & 4, common 3 C	Sensor Monitoring External E	Gauge² No gauge N Dial gauge ³ (standard) G Digital gauge ³ D MPS-P34 pressure sensor M

Notes:

- For 1/2" connections use 1/2" port blocks on standard 3/4" housing.
- Safety valve supplied with 1/8" gauge port in either BSPP or NPT threads as specified for ports. Gauges shipped loose.
- Dial or digital gauge not available on BSPP version.

Note: Mounting hardware and port blocks are sold separately.

See offer of sale: www.parker.com/offerofsale

Solenoid M12 Pinouts

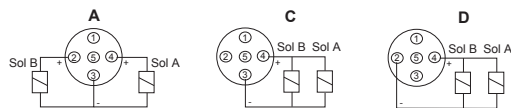

Pressure Sensor M12 Pinouts

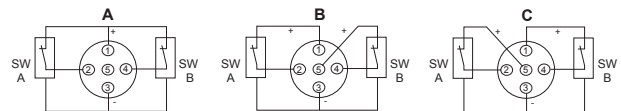

Mounting Hardware

Female M12 Cable, 5 pin, 2 meter length with flying leads **CB-M12-5P-2M** (two required)

Body Connector **P32KA00CB**

T-Bracket w / Body Connector **P32KA00MT**

T-Bracket **P32KA00MB** (fits to body connector or port block)

Port Block Kits (includes two)

1/2" NPT
P32KA94CP

1/2" BSPT
P32KA24CP

1/2" BSPP
P32KA14CP

3/4" NPT
P32KA96CP

3/4" BSPT
P32KA26CP

3/4" BSPP
P32KA16CP

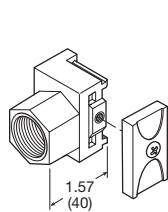

Port Block Kits

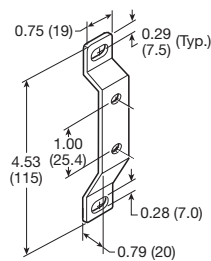

T-Bracket

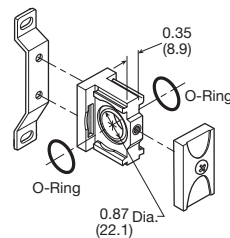

T-Bracket w/ Body Connector

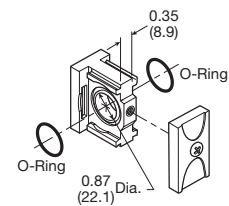

Body Connector

www.parker.com/pdn/safetyvalve

© 2019 Parker Hannifin Corporation

Bulletin 0700-B14 04/2021



Parker Hannifin Corporation

Pneumatic Division

8676 E. M89

Richland, MI 49083 USA

Tel: 269 629 5000

Applications Engineering: pdnapps@parker.com

Customer Support: pdncustsvc@parker.com